

VR-8X00-SMB(S)



Quick Guide V 1.00

VR-8X00-SMB(S) DECT master phone

1. Overview

This phone is a full-feature telephone that provides voice communication. Read this QIG carefully to learn how to operate this product and take advantage of its features.

Package Contents

When unpacking the phone, ensure all the following items are present and undamaged. If anything appears to be missing or broken, contact your dealer for a replacement.

1. Cordless Handset
2. Charging Stand
3. Battery
4. AC Adaptor
5. Quick Installation Guide (This document)

2. Product Description

The following contains important information to help you familiarize with the functions of the phone.

Front View

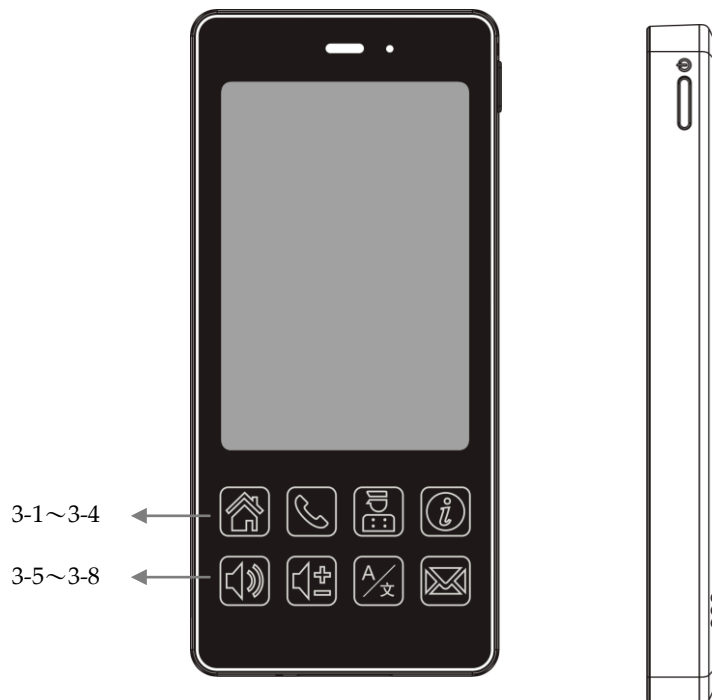

item	Name	Description
1	Display screen	Touchable display
2	Power key	Press to power on/off
3	Function key	
3-1	Home key	Press to return to idle page
3-2	Dial key	Press these keys to enter phone numbers.
3-3	Service key	Press to enter service page.
3-4	Dialing Instruction key	Press to enter Dialing Instructions page.

item	Name	Description
		Red LED turns on when handset is charging, Red LED turns off when handset is fully charged,
3-5	Speaker key	Press to activates the speakerphone for hands free conversations.
3-6	Volume + -	Press to increase or decrease the volume of the ringer tone, handset, or speakerphone.
3-7	Language key	Press to select display language
3-8	Message key	Press to listen to voice messages. Red LED turns on while there is unheard voice message.

Rear view

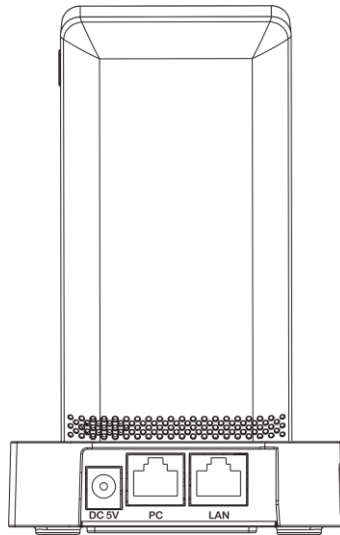

Name	Description
DC jack	Connects to AC power adapter.
PC port	Connects to computer
LAN port	Connects to HUB, ADSL, or Switch(PSE)

Side view

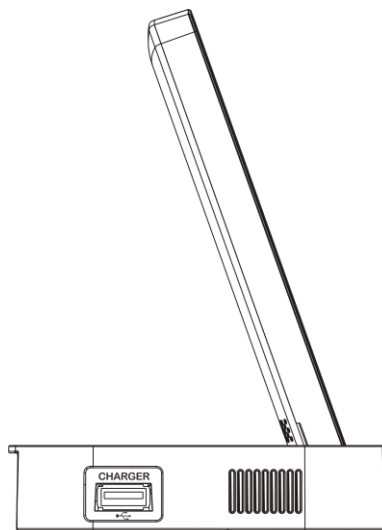

Name	Description
USB Charger port	Connects to charging cable of mobile device.

Bottom view

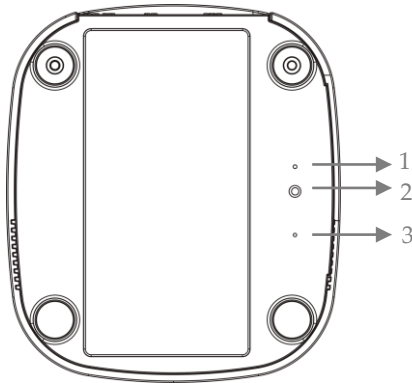

Item	Name	Description
1	Debug LED	Debug LED
2	Handset search button	To search handset
3	Reset	Press to reset DECT base station.

Battery Installation

The following illustration shows how to install the handset and battery.

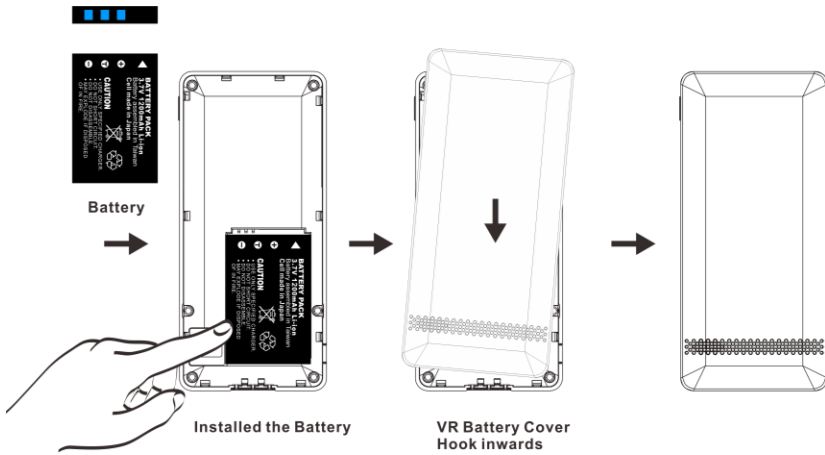
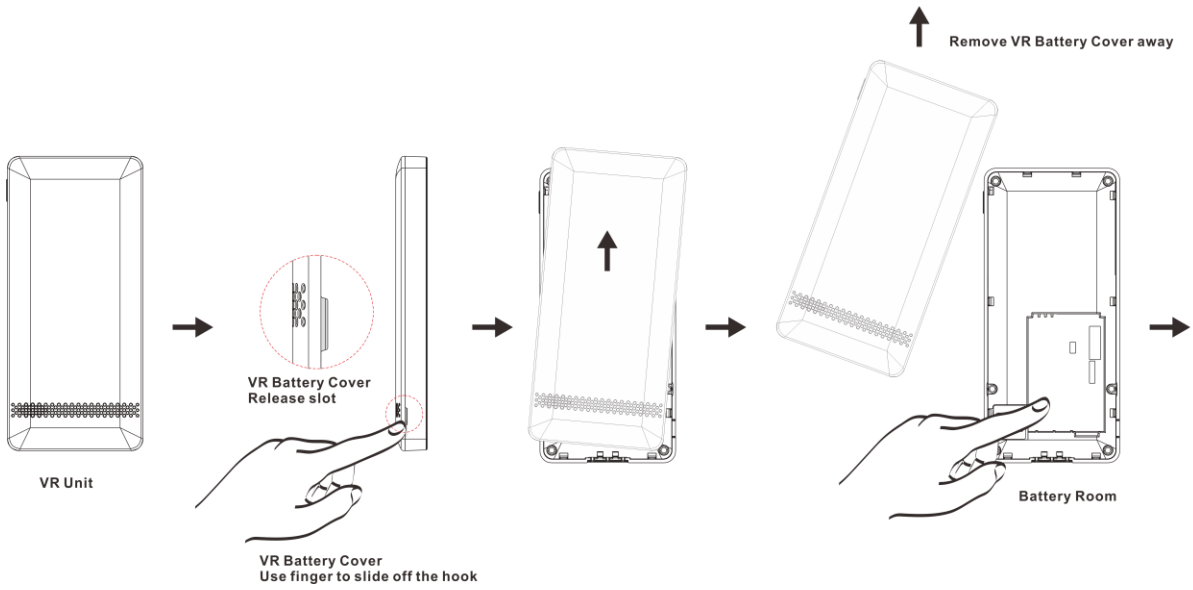

3. Operations

Answering a Call

An incoming call is indicated by a ringing tone. You can answer the call by doing one of the followings:

- Press the **Dial** key on the handset to answer the call.

Making a Call

Press **Dial** key  for numerical keypad.

- Press to enter the telephone number with green dial key  to make a call..

Using the service function

To use the pre-assigned service function for the most commonly dialed numbers. Use the function to dial a number quickly, instead of keying in a complete number.

- Press **Service** key. 
- Tap the icon to call desired service.

Using the Speaker Phone

- While talking on the phone, press the **SPEAKER** key  on the phone fo hands free conversation.

Charging the Handset Battery

You would need to charge the handset battery before using the handset.

- Install the battery into the handset.
- Place the handset onto the base unit and base unit will start to charge the handset automatically.
- This icon  will show charging progress.

4. Support

For technological support, please email to support@aeicommunication.com.